

Inspiration Robotics

A Brief Overview

Team Inspiration

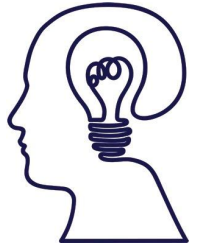

About Team Inspiration



- Our Mission
 - To learn, to share, to innovate, to inspire!
- Robotics Involvement
 - Learning robotics since 3rd grade
 - Compete in FLL, FTC, Robocar, RoboSub, and RobotX
 - Host robotics events in local communities since 2012
 - Host robotics events in international communities since 2019
 - Advisory team for FIRST Global – 175 nations
- Teaching STEM since 2017
 - Weeklong robotics camps
 - Guide local and global robotics teams and coaches
 - On average, weekly STEM teaching and mentoring



Leadership, systems engineering, global impact

Outreach



School/community

- K-12, Mesa College, UCSD, USD
- Fleet Science Center, Maker Faire

Underserved community

- Monarch School for homeless
- UrbanLife Ministry
- San Diego refugee tutoring

Charity

- ASTA, FFCC, ADA, TEMAS

Global

- Benin, Ecuador, Paraguay, and Togo



We strive to share our experiences and STEM education with others

FIRST



FIRST Tech Challenge

- Autonomous and remotely controlled robots
- Learning robotics principles and systems engineering processes as a stepping stone to more complex competitions
- Engage in vibrant local community through competitions to learn from one another's designs

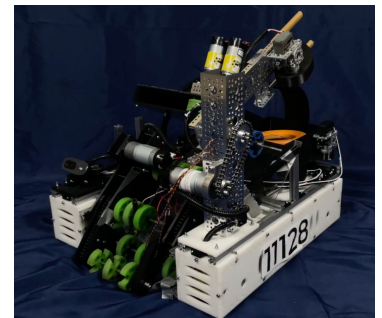
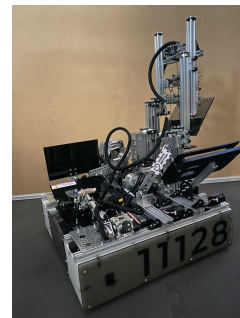
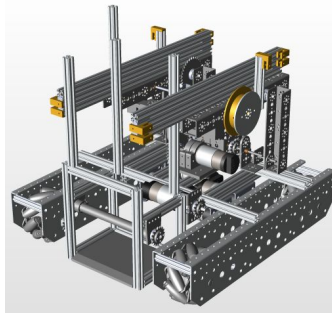
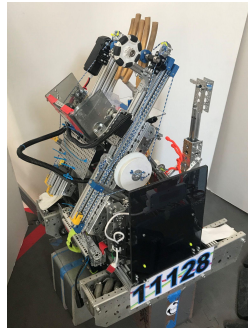

Building new robots using the design process in new robotics challenges/tasks each year

Autonomous Kart



Self Racing Cars – joint UCSD development

- Autonomous car development, ranked 2nd in the competition



Testing payloads and programs on land platforms before integrating on ocean platforms

RoboSub



“RoboSub is an international student competition. Student teams from around the world design and build robotic submarines, otherwise known as Autonomous Underwater Vehicles (AUV). The behaviors demonstrated by these experimental AUVs mimics those of real-world systems, currently deployed around the world for underwater exploration, seafloor mapping, and sonar localization, amongst many others.”

- [RoboSub official website](#)

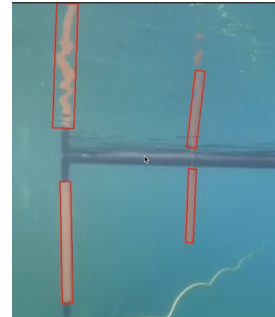

RoboSub



2019 Results

- Ranked 3rd out of 59 teams in Static Judging
- Ranked 12th out of 59 teams in Overall Performance
- Most Inspirational Team award
- IEEE Innovation award



2020 Results

- Ranked 1st out of 33 teams in Overall Performance
- Ranked 1st out of 33 teams in Technical Design Report
- Ranked 1st out of 33 teams in Website
- Ranked 2nd out of 33 teams in Video



2021 Results

- 4th for the Hull Design Skills Video out of 34 submissions
- 8th for the Sensor Optimization Video out of 26 submissions
- 8th for Website out of 53 submissions
- 13th for the Technical Design Report out of 53 submissions

RobotX

“RobotX is an international program where innovators can grow their potential and make substantial contributions to the robotics community. Through three distinct platforms (Challenge, Interactive and Virtual), connect and collaborate with fellow innovators to achieve greater breakthroughs, and add your voice to the robotics community.”

- [RobotX official website](#)

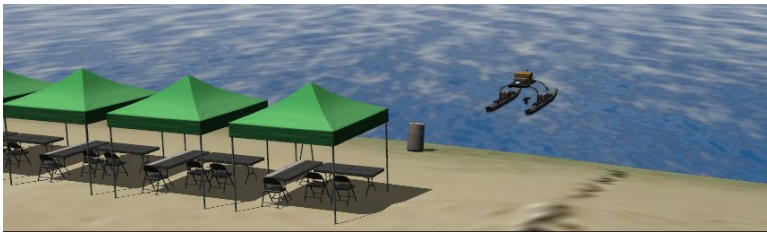
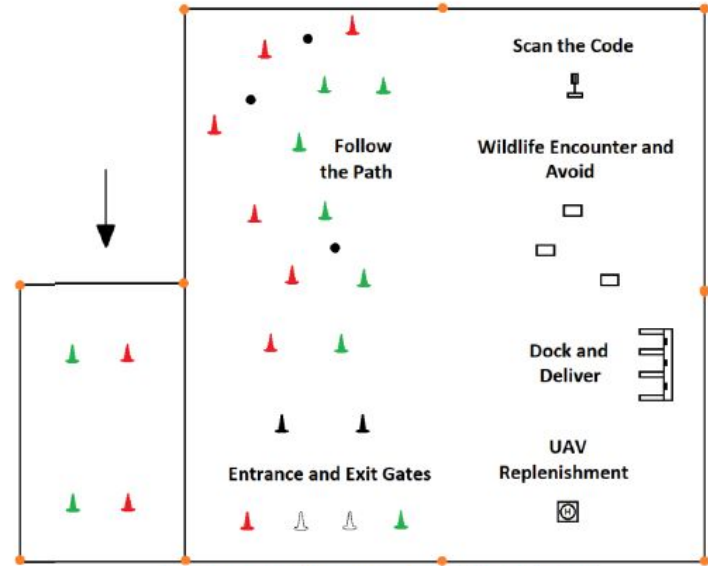

RobotX – Nov 2022, Sydney, Australia

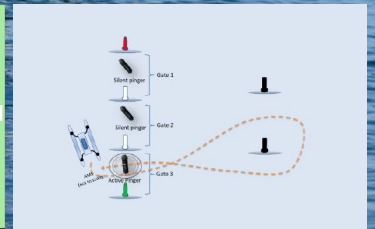
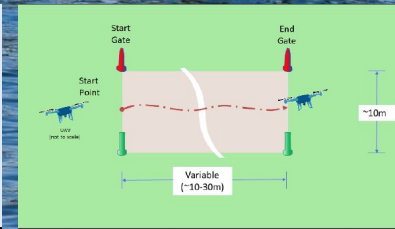
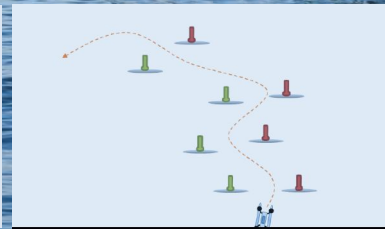
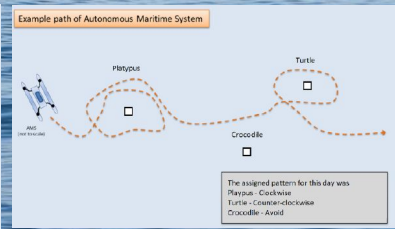
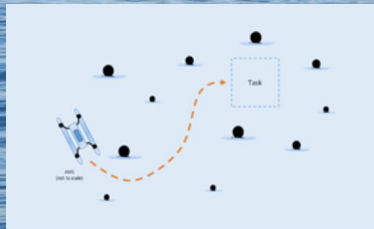

RobotX Competitors



14 teams competed in 2018

- Embry-Riddle Aeronautical University
- Florida Atlantic University
- Georgia Institute of Technology
- Harbin Engineering University
- Nanyang Technological University
- National Chiao Tung University
- Old Dominion University
- Osaka Prefecture University - Osaka University
- Queensland University of Technology
- University of Florida
- University of Hawaii at Manoa
- University of Michigan
- The University of Newcastle
- The University of Sydney

9 new teams for 2022

- George Mason University (USA)
- Istanbul Technical University (TURKEY)
- James Cook University (AUSTRALIA)
- Libera Università di Bolzano (ITALY) / Lake Superior State University (USA)
- Pontificia Universidad Católica de Chile (CHILE)
- Pontificia Universidad Católica del Perú (PERU)
- Team Inspiration (USA)
- The University of Queensland (AUSTRALIA)
- University of South Australia (AUSTRALIA)

Accomplishments



RobotX invitation - most advanced RoboNation competition

RoboSub

- 2021 (50 of the 54 teams are from universities around the world)
 - 4th in the world for Skills Video: Hull Design
 - 8th in the world for Website
- 2020 RoboSub world champion – first high (middle) school team in the 23 years history
- 2019 (55 of the 59 teams are from universities around the world)
 - 2nd in US and 3rd in the world for static judging
 - 7th in US and 12th in the world for overall robot performance
 - Most Inspirational Team award
 - IEEE Innovation award



FIRST robotics

- 2017/2018/2020 FIRST robotics world championship

Coaches multiple award winning teams and mentors

- 2017 Team Benin ranked 7th in the FIRST Global World competition, 1st in Africa
- 2018 FIRST Global Best Mentor (Team Benin) in the world



Support We Need



Subject matter experts

- Mechanical (drone, boat, propulsion design)
- CAD
- FPGA designer
- PCB designer
- Systems engineers
- Sensor integrator
- Artificial intelligence
- Simulation (Unity and Gazebo)
- Data analyst
- Computer vision
- Control systems
- Software architect
- Grant writers
- Web page design

Materials

- Lab space
- Sensors (borrowed/loaned)
- Drone parts
- Boat trailer
- Boat (on water support for in person testing)

We are also looking for university students to join the team, looking for about 25 students that match the topics listed on the left.

Fundraising Goal - \$105,000

Sponsorship Levels



Sponsorship Level	Diamond	Platinum	Gold	Silver	Bronze
Donation	\$10,000+	\$5,000 - \$9,999	\$2,500 - \$4,999	\$1,000 - \$2,499	\$500 - \$1,000
Training event for sponsor	x				
STEM events for sponsor	up to 4 events	up to 2 events	1 event		
Company name on competition journal papers	x	x	x		
Company logo placed on competition vehicle	large	large	medium	small	
Company name & logo on website	x	x	x	x	x
Company name on competition posters & brochures	x	x	x	x	x
Promotion on our social media channels	x	x	x	x	x

Acknowledgements



Team Inspiration Members

Lead coaches

- Alex Szeto, Jack Silberman

Mentors

- Amit Goel, Brian Liu, Dave Warner, Eric Lo, Eugene Kim, Kenzo Tomitaka, Kris Chopper, Kunal Srivastava, Pamela Cosman, Pat McLaughlin, Phil Yao, Michael Arnstein, Valibabu Saladi, and Venkat Rangan

Sponsors/supporters



To Inspire



Join our journey to promote STEM learning

Your support is needed



<https://www.teaminspiration.global/>

11128inspiration@gmail.com



 [ftc11128inspiration](https://www.instagram.com/ftc11128inspiration)

 [teaminspiration11128](https://www.facebook.com/teaminspiration11128)

 [Inspiration Robotics 11128](https://www.youtube.com/channel/UC...)

